

Kabel- schutzrohr Konsole Typ KRh 6 – 3w	Support pour tuyaux à câbles Type KRh 6 – 3w	Supporto per tubi di cavi Tipo KRh 6 – 3w	Cable Conduit Console Type KRh 6 – 3w
---	---	--	--

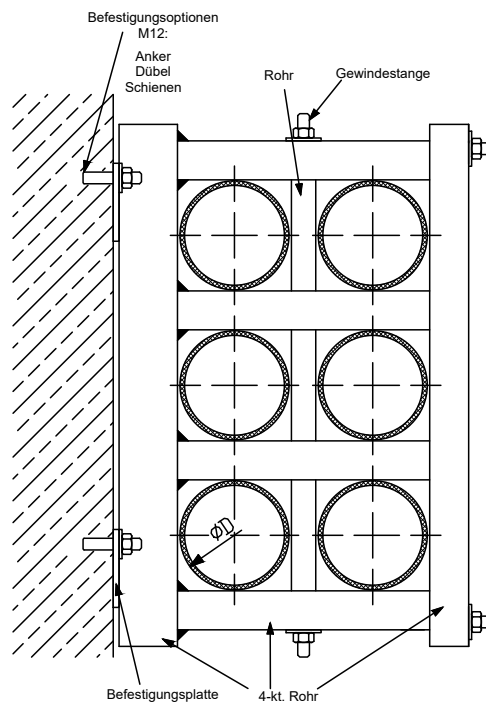

Konstruktion mit Distanzrohr	Construction avec tubes de distance	Costruzione con tubo in filato	Construction with spacer tube
4kt Profile: 40 x 40 mm Gewindestangen Schrauben Muttern M12 Verankerung: Klebeanker, Kompaktdübel, Gewindeplatte Werkstoffe, wahlweise : Stahl feuerverzinkt, Stahl rostfrei Klasse A4 (1.4401 / 1.4404 / 1.4571) Kabelschutzrohr DE 70 bis 214	profilés: 40 x 40 mm tige filetée, vis, écrou M12 ancrage: ancrage collé, chevilles, plaque filetée matériaux à choix: galvanisé à chaud acier inoxydable classe A4 (1.4401 / 1.4404 / 1.4571) tube à câble DE 70 à 214	profili: 40 x 40 mm barra filettata, viti, dadi M12 ancoraggio: chimico, meccanico, piastra filettata materiale a scelta: acciaio zincato a bagno acciaio inox A4 (1.4401 / 1.4404 / 1.4571) tubi per cavi DE 70 - 214	Profile: 40 x 40 mm Threaded rods Screws, Nuts M12 Anchorage: Adhesive anchors, Compact dowels, Threaded plates Materials, optional : Galvanized steel, Stainless Steel Grade A4 (1.4401 / 1.4404 / 1.4571) Cable conduit DE 70 to 214